

Technical Manual

MDT Switch Actuator



Series AKK:

AKK-0810A.01

AKK-01UP.01

AKK-02UP.01

AKK-0216.01 (until Q2 – 2014)

AKK-0406.01 (until Q2 – 2014)

AKK-0816.01 (until Q2 – 2014)

AKK-0810.01 (until Q2 – 2014)

AKK-1616.01 (until Q2 – 2014)

AKK-1610.01 (until Q2 – 2014)

AKK-0216.02 (from Q2 – 2014)

AKK-0416.02 (from Q2 – 2014)

AKK-0816.02 (from Q2 – 2014)

AKK-1616.02 (from Q2 – 2014)

1 Content

1 Content.....	2
2 Overview.....	4
2.1 Overview devices.....	4
2.2 Exemplary circuit diagrams	5
2.3 Structure & Handling.....	6
2.4 Functions	7
2.4.1 Overview functions.....	7
2.5. Settings at the ETS-Software	8
2.6. Starting up	8
3 Communication objects.....	9
3.1 Summary and Usage.....	9
3.2 Default settings of the communication objects	12
4 Reference ETS-Parameter	13
4.1 General Settings	13
4.2 Channel selection	14
4.3 Identical parameter	15
4.3.1 Relay operating mode	15
4.3.2 Central function.....	16
4.3.3 Behavior at block/unblock.....	16
4.3.4 Behavior at bus power up/down.....	18
4.4 Switching output	19
4.4.1 Overview.....	19
4.4.2 On/Off delay	21
4.4.3 Logical functions.....	22
4.4.4 Scene function.....	24
4.5 Staircase	29
4.5.1 Overview.....	29
4.5.2 Staircase time	31
4.5.3 Prewarning und Warning	32
4.5.4 Manual switch off.....	33
4.5.5 Extend staircase time	33
5 Index.....	34
5.1 Register of illustrations.....	34
5.2 List of tables.....	35

6 Attachment.....	36
6.1 Statutory requirements.....	36
6.2 Routine disposal	36
6.3 Assemblage.....	36
6.4 Datasheet	37

2 Overview

2.1 Overview devices

The manual refers to the following devices (Order Code respectively printed in bold type). For the actuators with integrated current measurement, a separate manual exists.

Old series (bis Q4 - 2014): monostable Relaiy

- **AKK-0810A.01** Switch actuator 8-fold, surface mounted, 230V AC, 10 A, compact design
- **AKK-01UP.01** Switch actuator 1-fold, flush-mounted, 230V AC, 16 A, compact design
- **AKK-02UP.01** Switch actuator 2-fold, flush mounted, 230V AC, 6 A, compact design
- **AKK-0216.01** Switch actuator 2-fold, 2TE, 230V AC, 16 A, compact design
- **AKK-0406.01** Switch actuator 4-fold, 4TE, 230V AC, 6 A, compact design
- **AKK-0816.01** Switch actuator 8-fold, 4TE, 230V AC, 16 A, compact design
- **AKK-0810.01** Switch actuator 8-fold, 4TE, 230V AC, 10 A, compact design
- **AKK-1616.01** Switch actuator 16-fold, 8TE, 230V AC, 16 A, compact design
- **AKK-1610.01** Switch actuator 16-fold, 8TE, 230V AC, 10 A, compact design

New series (ab Q4 - 2014): bistable Relaiy

- **AKK-0216.02** Switch actuator 2-fold, 2TE, 230V AC, 16 A, compact design
- **AKK-0416.02** Switch actuator 4-fold, 4TE, 230V AC, 16 A, compact design
- **AKK-0816.02** Switch actuator 8-fold, 4TE, 230V AC, 16 A, compact design
- **AKK-1616.02** Switch actuator 16-fold, 8TE, 230V AC, 16 A, compact design

The functions of the actuators of the new series are the same as the one of the first series. Only design and the circuit diagram are different. For detailed information have a look at the next segment, 2.2 Exemplary circuit diagrams, or at the datasheets of the new series.

2.2 Exemplary circuit diagrams

Old series (supplied by supply voltage):

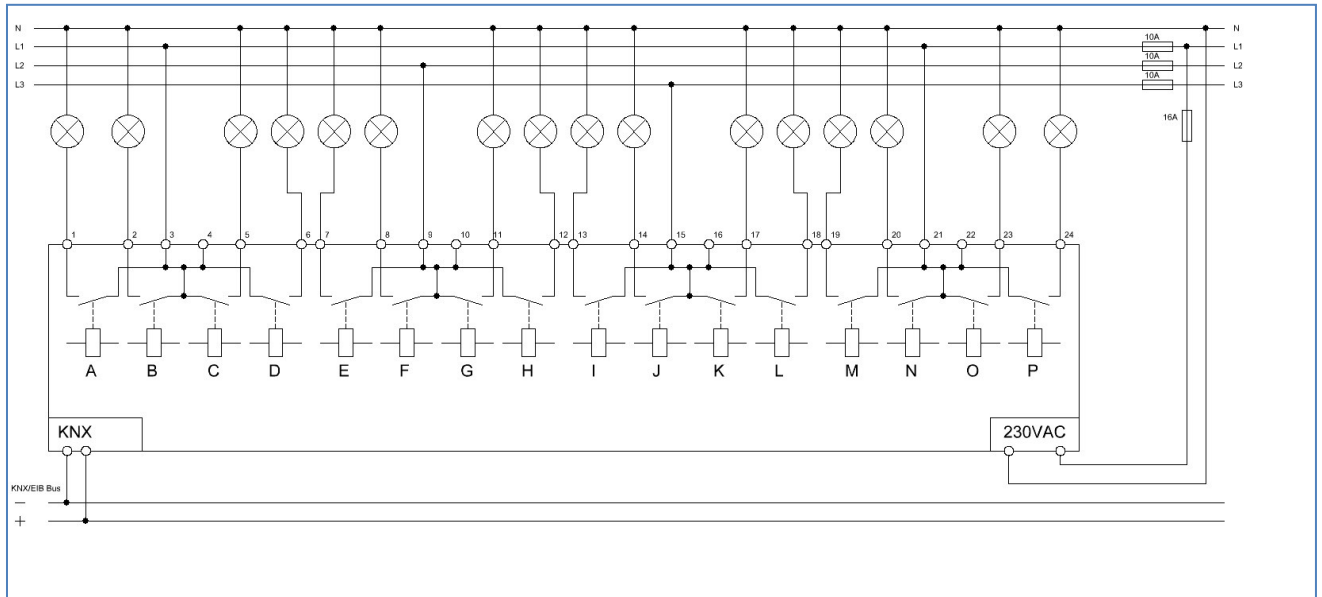

Figure 1: Exemplary circuit diagram AKK-1610.01

New series (supplied by bus voltage):

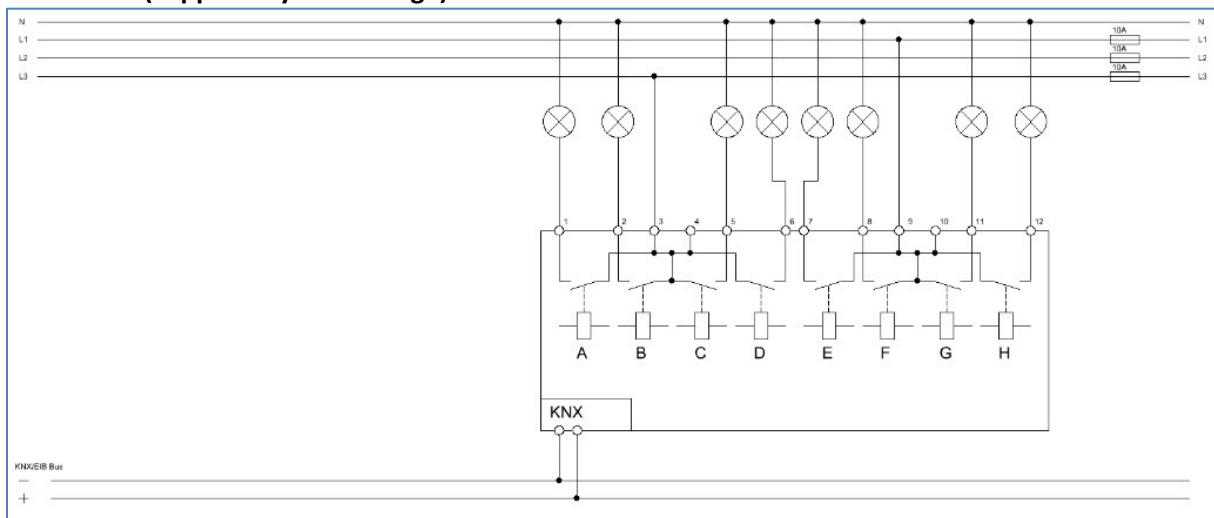

Figure 2: Exemplary circuit diagram AKK-0816.02

2.3 Structure & Handling

The switch actuators (here: AKI 1216.01) contain of one status LED per channel. This LED indicates the state of the depending output. Furthermore every output can be switched manual, independent of the current parameterization. The lines AKS and AKI have buttons for every channel. In contrast the line of the AKK has only four buttons, independent to the number of channels. Two buttons are for choosing the channel, whereby the chosen channel is indicated by a flashing status LED. The buttons up and down are for switching the channel on and off. The programming button activates the programming function. An activated programming function is indicated by a lit programming LED.

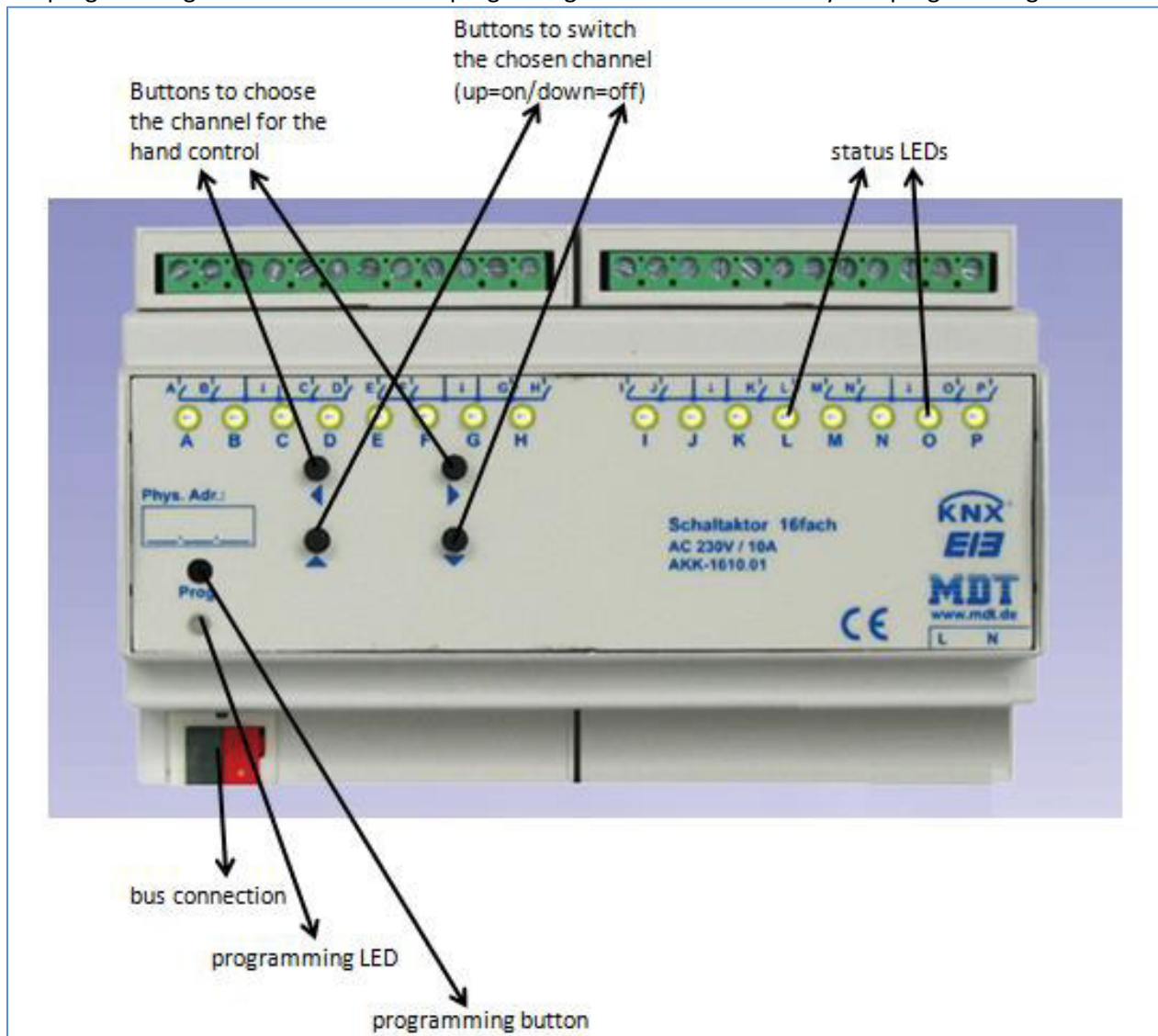

Figure 3: Overview hardware module switch actuator (e.g. AKK-1610.01)

The lines AKS and AKI have bistable relays. The line AKK has monostable relays. At the bistable relays the current switching state also stays in case of a breakdown of the 230V auxiliary voltage and at an update of the parameterization. The monostable relays fall back to their output state when the power breaks down or the parameterization is updated.

2.4 Functions

All of the channels have identical functions (have a look at the functional overview). The numbers of channels depends to the hardware design, which can have 2, 4, 8, 12 or 16 channels. The identification is standardly in consecutive alphabetic order.

There are 3 different states for every channel possible:

- **not active**

The channel has no function. So there are no communication objects for this channel shown.

- **Switch**

If the channel is chosen as switch, there will be different parameterization options for configuring the switching process.

- **Staircase**

Now, the channel can become a staircase light function. This function causes an automatic switch off of the channel after an adjusted time.

2.4.1 Overview functions

Group of functions	Functions
Group addresses	number of objects/connections= dynamic (freely assignable of the user)
Reset behavior	behavior at bus power breakdown
	behavior at bus power up
	startup timeout
Relay mode	normally closed/ normally opened
Switch functions	switching
	central switching function
Time functions	on-delay
	off-delay
Staircase light functions	time for staircase
	pre-warning (with adjustable warning and pre-warning time)
	manual off
	retriggerable on/off
Superordinate functions	blocking function
	logic functions (AND/ OR)
Scenes	scene function for up to 8 scenes per channel
Status functions	feedback function

Table 1: Overview functional possibilities

2.5. Settings at the ETS-Software

Selection at the product database:

Manufacturer: MDT Technologies

Product family: Actuator

Product type: Switch Actuators

Medium Type: Twisted Pair (TP)

Product name: addicted to the used type, e.g.: AKI-1216.01 switch actuator 12-fold, 8TE, 16A

Order number: addicted to the used type, e.g.: AKI-1216.01

2.6. Starting up

After wiring, the allocation of the physical address and the parameterization of every channel follow:

- (1) Connect the interface with the bus, e.g. MDT USB interface
- (2) Switching the power supply
- (3) Set bus power up
- (4) Press the programming button at the device (red programming LED lights)
- (5) Loading of the physical address out of the ETS-Software by using the interface (red LED goes out, as well this process was completed successful)
- (6) Loading of the application, with requested parameterization
- (7) If the device is enabled you can test the requested functions (also possible by using the ETS-Software)

3 Communication objects

3.1 Summary and Usage

Nr.	Name	Object function	Data type	Direction	Info	Usage	Tip
global Objects:							
according to the number of channels	Central function	Switch On/Off	DPT 1.001	receive	Actuator reacts to Incoming-telegramm	Push buttons, Visu... for manual control	Communication object is always shown and enables controlling the standard function "Switch On/Off" , for all channels with activated central function , which is normally connected to all control keys.
Objects per channel:							
0	Channel A	Switch On/Off	DPT 1.001	receive	Actuator reacts to Incoming-telegramm	Push buttons, Visu... for manual control	Standard function of the Channel function "Switch", which enables the switching of the output.
1	Channel A	Staircase	DPT 1.001	receive	Actuator reacts to Incoming-telegramm	Push buttons, Visu... for manual control	Standard function of the Channel function "Staircase", which enables the switching of the output at which the channel switches off automatically after the parameterized time.

Technical Manual Switch Actuators AKI/AKS/AKK

2	Channel A	Block	DPT 1.003	receive	Actuator reacts to Incoming-telegramm	Push buttons, Visu... for manual control	This communication object is always shown for an activated channel and allows the blocking of the channel with simultaneously calling of parameterized states.
4	Channel A	Scene	DPT 18.001	receive	Actuator reacts to Incoming-telegramm	Push buttons, Visu... for manual control	This communication object is only shown after activating the scene function and allows the calling of 8 parameterized scenes. (= Additional function)
5	Channel A	State	DPT 1.001	send	Actuator sends current switching state	Visu, Connection to the object „Value for Toggle“ of Push Buttons	This communication object is always shown for an activated channel and sends the current output state of the channel.

Technical Manual Switch Actuators AKI/AKS/AKK

Logical functions per channel:							
6	Channel A	Logic 1	DPT 1.001	receive	Actuator reacts to Incoming-telegramm	Push buttons, Visu... for manual control	This communication object is only shown after activating the Logical functions and can be used for switching the channel according to the adjusted logical setting. (= Additional function)
7	Channel A	Logic 2	DPT 1.001	receive	Actuator reacts to Incoming-telegramm	Push buttons, Visu... for manual control	This communication object is only shown after activating the Logical functions and can be used for switching the channel according to the adjusted logical setting. (= Additional function)

Table 2: Communication Objects

3.2 Default settings of the communication objects

The following chart shows the default settings of the communication objects:

Default settings									
Nr.	Name	Object Function	Length	Priority	C	R	W	T	U
0	Channel A	switch on/off	1 Bit	Low	X		X		
1	Channel A	Staircase	1 Bit	Low	X		X		
2	Channel A	Block	1 Bit	Low	X		X		
4	Channel A	Scene	1 Byte	Low	X		X		
5	Channel A	Status	1 Bit	Low	X	X		X	
6	Channel A	Logic 1	1 Bit	Low	X		X		
7	Channel A	Logic 2	1 Bit	Low	X		X		
+8	next channel								
96 128	Central function	switch on/off	1 Bit	Low	X		X		

Table 3: Communication objects – default settings

You can see the default values for the communication objects from the upper chart. According to requirements the priority of the particular communication objects as well as the flags can be adjusted by the user. The flags allocates the function of the objects in the programming thereby stands C for communication, R for Read, W for write, T for transmit and U for update.

4 Reference ETS-Parameter

4.1 General Settings

The following parameter exists only once and affects to all channels:

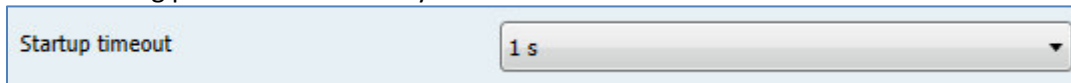

Figure 4: General settings

The parameter startup timeout adjusts the time between an upload and the functional start of the device. The used hardware reacts only after expiration of the adjusted time. All input commands before the startup timeout expire.

The following chart shows the dynamic range of this parameter:

ETS-text	Dynamic range [default value]	comment
Startup timeout	1-60s [1s]	Time between an upload and the functional start of the device

Table 4: General settings

4.2 Channel selection

The following illustration shows the menu for selecting the channels:

Channel A	Staircase
Channel B	Switch
Channel C	not activ
Channel D	not activ
Channel E	not activ
Channel F	not activ
Channel G	not activ
Channel H	not activ
Channel I	not activ
Channel J	not activ
Channel K	not activ
Channel L	not activ

Figure 5: Channel selection

There are 3 possible states for every channel, which can be adjusted at the menu “channel preselection”. The following parameterization accords to the chosen state of a channel. But if you chose a channel as “not active”, there will be no further parameterization options available.

The chart shows the setting options for every channel:

ETS-text	Dynamic range [default value]	comment
Channel A-[T]	<ul style="list-style-type: none"> ▪ not active ▪ Switch ▪ Staircase 	Operating mode of the channels

Table 5: Channel selection

4.3 Identical parameter

The following parameters, which are described at the headings 4.3.x, are as well available at channels selected as switch as at channels selected as staircase.

4.3.1 Relay operating mode

The following illustration shows the setting options for this parameter:

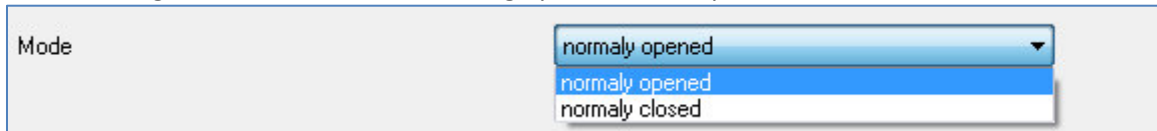

Figure 6: Operating mode

The following chart shows the dynamic range for this parameter:

ETS-text	Dynamic range [default value]	comment
Mode	<ul style="list-style-type: none"> ▪ normally opened ▪ normally closed 	Relay operating mode of the channel

Table 6: Operating mode

The following diagram shows the behavior of the relay operating mode normally closed and normally opened. The input for the channels is a KNX-telegram, which sends alternating 0-signals and 1-signals:

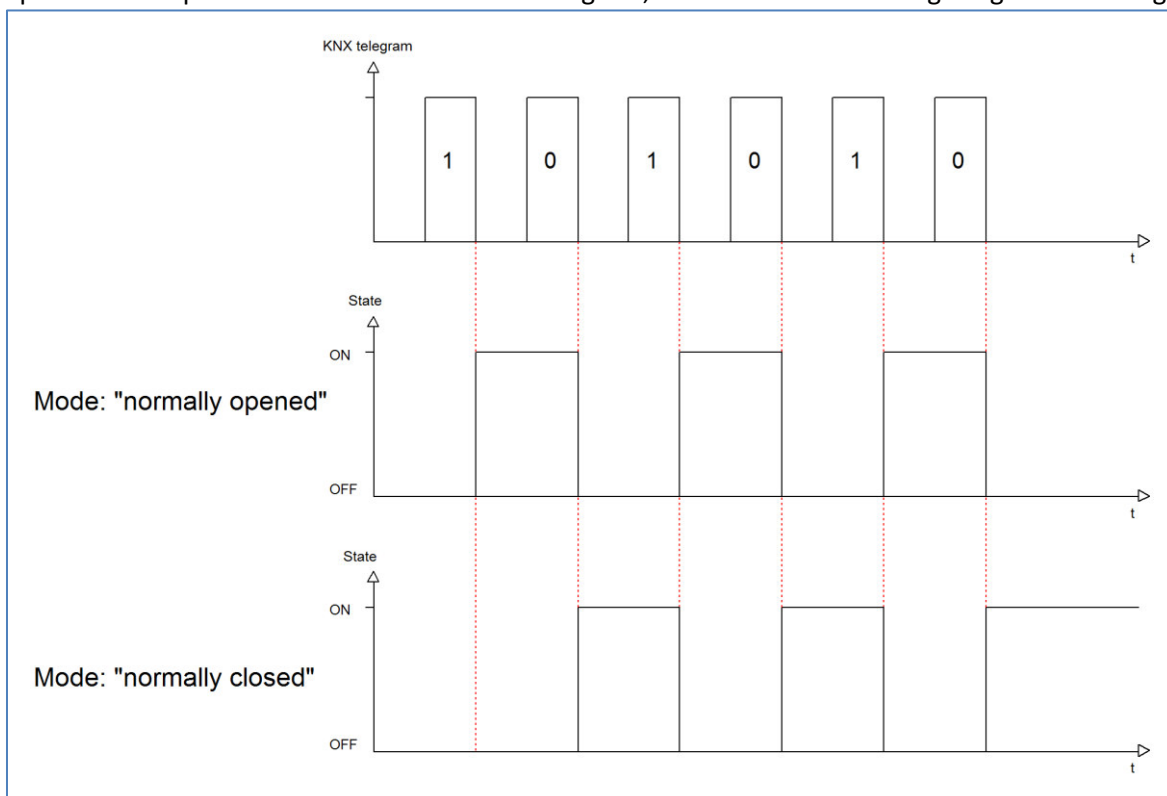

4.3.2 Central function

The following illustration shows the setting options at the ETS-Software:

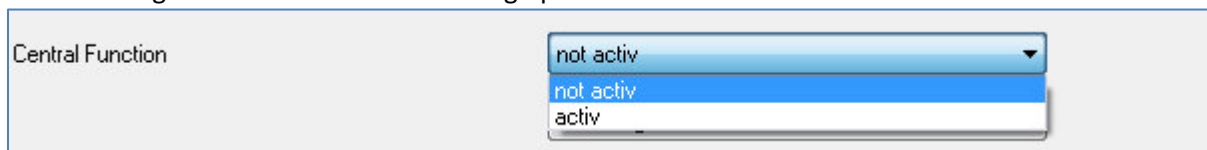

Figure 7: Central function

The following chart shows the dynamic range for this parameter:

ETS-text	Dynamic range [default value]	comment
Central function	<ul style="list-style-type: none"> ▪ not active ▪ active 	switches the central function on/off for this channel

Table 7: Central function

The central function can be switched on/off for every channel. For switching on this function, you have to choose the option “active”. By calling the central communication object, all channels with an activated central function are switched on with their current parameterization. So switch-on delays or staircase functions are still kept.

The central function can make programming much more easier and your project can become more clear.

The following chart shows the associated communication object:

Number	Name	Length	Usage
	Central function	1 Bit	central switching of the channels number depends to the number of channels

Table 8: Communication object central function

4.3.3 Behavior at block/unblock

The following illustration shows the setting options at the ETS-Software:

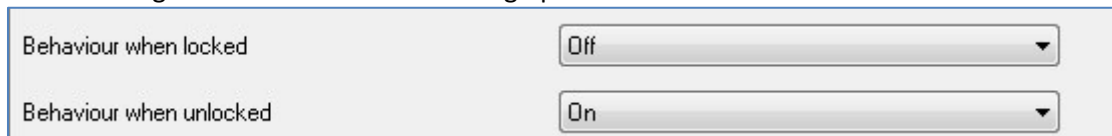

Figure 8: Blocking function

The following chart shows the dynamic range for this parameter:

ETS-text	Dynamic range [default value]	comment
Behavior when locked Behavior when unlocked	<ul style="list-style-type: none"> ▪ On ▪ Off ▪ no change 	Behavior to a blocking/unblocking process

Table 9: Behavior at block/unblock

The blocking function gets active, when the corresponding communication object becomes a logical "1". By sending a logical "0", the blocking function can be deactivated again.

The parameter "Behavior when locked" defines an action for the output at activating the blocking process. There are the setting on, off and no change available. The same settings are also available for the "Behavior when unlocked". This action is called when the blocking function is deactivated again.

The following chart shows the corresponding communication object:

Number	Name	Length	Usage
2	Block	1 Bit	blocks the channel

Table 10: Communication object blocking function

The following diagram describes the blocking process. For the "Behavior when locked", the action on was parameterized and for the "Behavior when unlocked" the action off was parameterized:

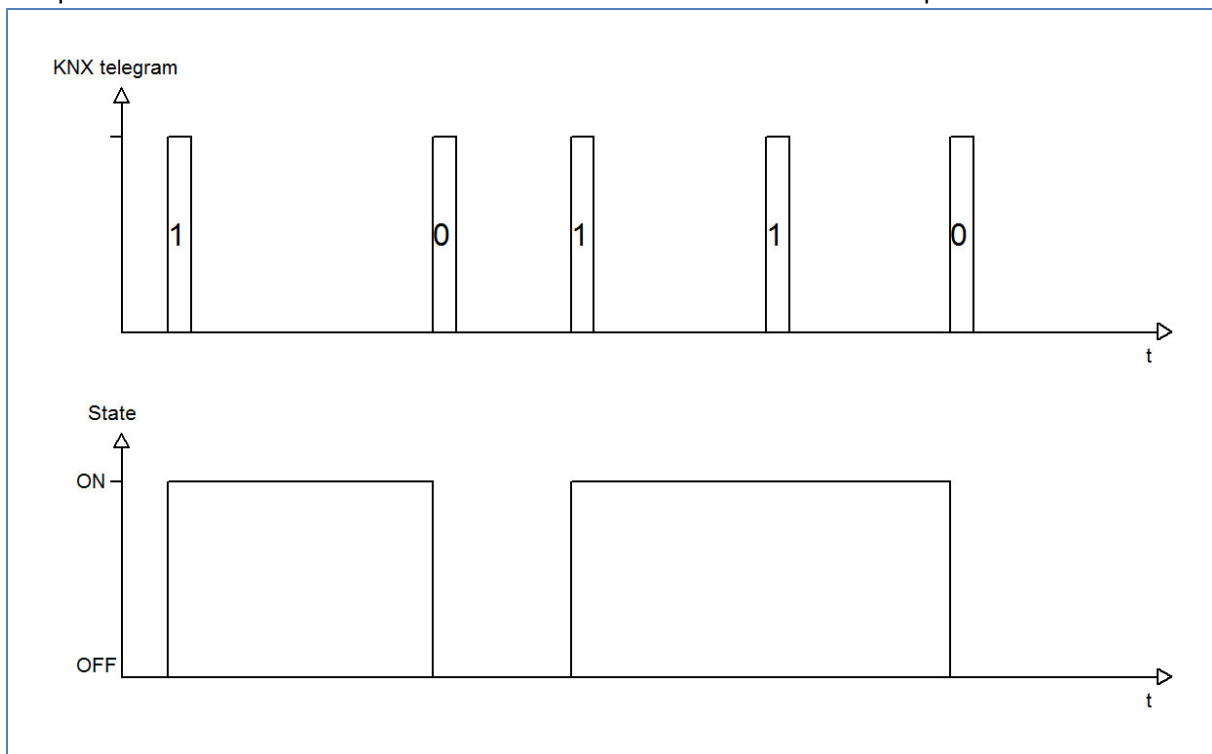

The KNX telegram shows which values are send to the blocking object. By sending a logical "1", the blocking function is activated and the channel is switched on. The blocking function is deactivated again by sending a logical "0". So the channel is switched off.

4.3.4 Behavior at bus power up/down

The following illustration shows the setting options at the ETS-Software:

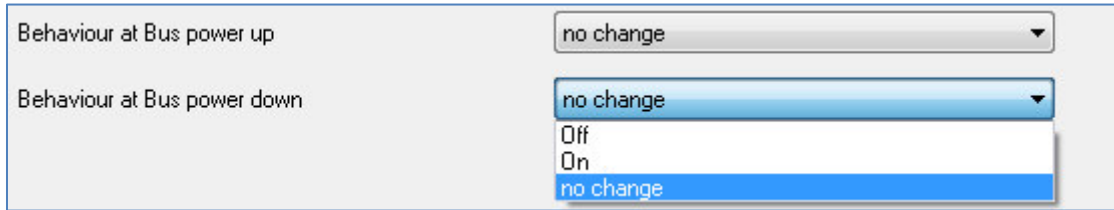

Figure 9: Behavior at bus power up/down

The following chart shows the dynamic range for this parameter:

ETS-text	Dynamic range [default value]	comment
Behavior at bus power up/ Behavior at bus power down	<ul style="list-style-type: none"> ▪ On ▪ Off ▪ no change 	Adjustment, how the channel shall react in case of a bus power breakdown/return

Table 11: Behavior at bus power up/down

Every channel can occupy a certain state as well in case of a bus power breakdown as in case of a bus power return. The channel can be switched off or on, but also stay in its current state by choosing the parameter “no change”.

To avoid problems in case of a bus power breakdown, you should adjust this parameter very conscientious. Because there is no controlling possible as long as the bus power is down.

4.4 Switching output

The following parameters, which are described at the headings 4.4.x, are only available at channels selected as switch.

4.4.1 Overview

By choosing a channel as switch, a sub menu, called Channel A Switching, appears for this channel at the left drop down menu.

The sub menu is shown at the following illustration:

Mode	normally open
On delay [s]	0
Off delay [s]	0
Central function	not activ
Behaviour when locked	no change
Behaviour when unlocked	no change
Behaviour at bus power up	no change
Behaviour at bus power down	no change
Logical functions	not activ
Scene	not activ

Figure 10: Switching output

The chart shows the possible settings for switching outputs:

ETS-text	Dynamic range [default value]	comment
Mode	<ul style="list-style-type: none"> ▪ normally opened ▪ normally closed 	Operation mode of the channel
On-Delay	0...30000 sec [0=no delay]	Switch on delay of the channel in seconds
Off-Delay	0...30000 sec [0=no delay]]	Switch off delay of the channel in seconds
Central function	<ul style="list-style-type: none"> ▪ not active ▪ active 	Activates the central function for this channel
Behavior when locked	<ul style="list-style-type: none"> ▪ Off ▪ On ▪ no change 	Action for activating the blocking process
Behavior when unlocked	<ul style="list-style-type: none"> ▪ Off ▪ On ▪ no change 	Action for deactivating the blocking process
Behavior at bus power down	<ul style="list-style-type: none"> ▪ Off ▪ On ▪ no change 	Action for a bus power breakdown
Behavior at bus power up	<ul style="list-style-type: none"> ▪ Off ▪ On ▪ no change 	Action for a bus power return
Logic function	<ul style="list-style-type: none"> ▪ not active ▪ with one object ▪ with two objects 	Activation of the logic function with one or two objects
Logic operation	<ul style="list-style-type: none"> ▪ And ▪ Or 	Selection of the logic function only available, when the logic function was activated
Scene	<ul style="list-style-type: none"> ▪ not active ▪ active 	Activation of the scene function by activation this parameter a new sub menu appears (have a look at 4.4.4)

Table 12: Switching output

4.4.2 On/Off delay

The following illustration shows the setting options at the ETS-Software:

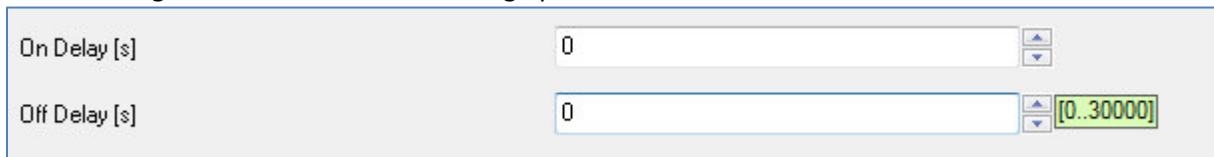

Figure 11: On/Off delay

The on-delay causes a delayed switch of the channel. At sending an on-signal to the channel, first the adjusted on delay time expires and afterwards the channel will be switched on.

The off delay works on the same principle. At sending an off-signal, first the adjusted off delay time expires and afterwards the channel will be switched off.

Both functions work as well alone as combined. By adjusting "0 seconds" for a delay the function is switched off.

The following diagram describes the combination of on and off delay:

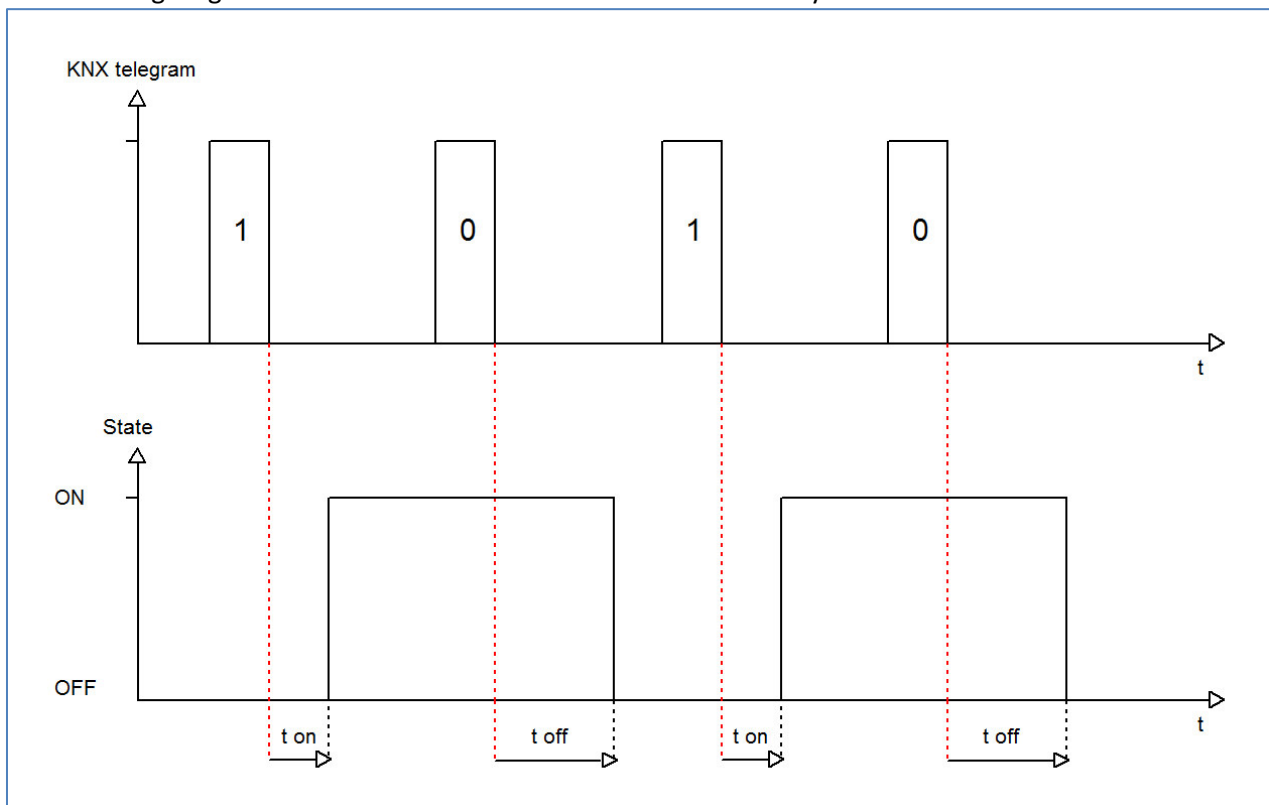

4.4.3 Logical functions

The following illustration shows the setting options at the ETS-Software:

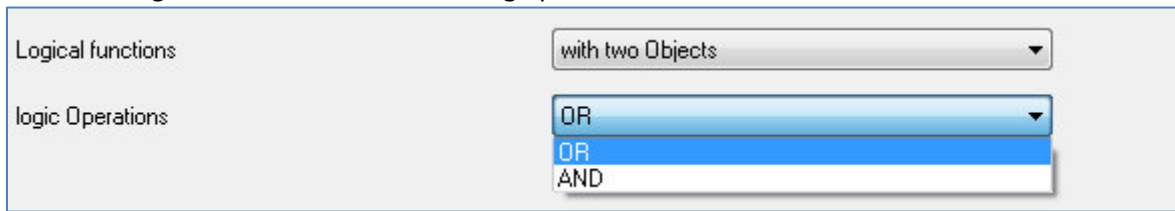

Figure 12: Logical functions

The logic function can be activated with one or two objects. The objects are the inputs of the logic block. Furthermore you can choose between an AND-function and an OR-function. The following figure shows an overview of the basic logic function with two objects:

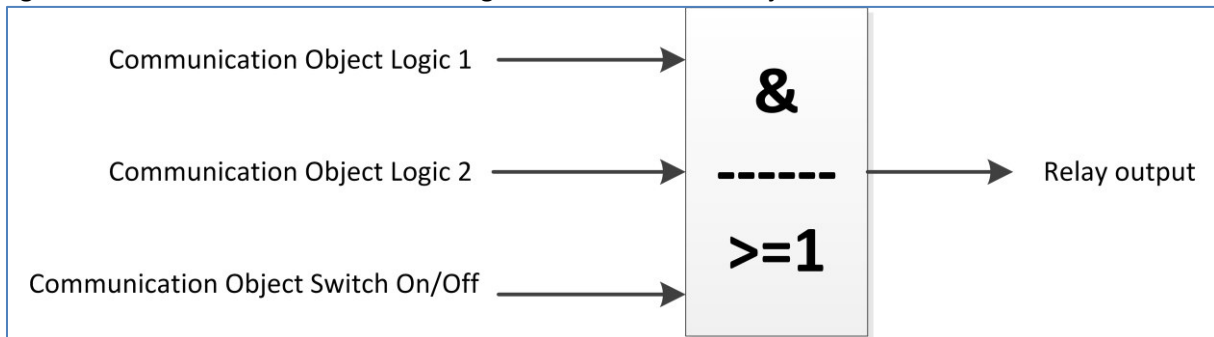

Figure 13: Overview Logic function

The logic function consists of the activated input objects and the switching object for each channel. The output of the logic is the respective relay output of the channel, so the physical switching of the channel.

The following chart shows the relevant communication objects:

Number	Name	Length	Usage
6	Logic 1	1 Bit	Logic object 1, is the first input for the logic block
7	Logic 2	1 Bit	Logic object 2, is the second input for the logic block

Table 13: Communication objects logic

The following table illustrates the two logic functions:

AND-Connection

OR-Connection

Switch On/Off	Logic 1	Logic 2	Channel switched?	Switch On/Off	Logic 1	Logic 2	Channel switched?
0	0	0	Nein	0	0	0	Nein
0	0	1	Nein	0	0	1	Ja
0	1	0	Nein	0	1	0	Ja
0	1	1	Nein	0	1	1	Ja
1	0	0	Nein	1	0	0	Ja
1	0	1	Nein	1	0	1	Ja
1	1	0	Nein	1	1	0	Ja
1	1	1	Ja	1	1	1	Ja

Table 14: Logic function

4.4.4 Scene function

When functions of different groups (e.g. light, heating and shutter) shall be changed simultaneously with only one keystroke, it is practical to use the scene function. By calling a scene, you can switch the lights to a specific value, drive the shutter to an absolute position, switch the heating to the day mode and switch the power supply of the sockets on. The telegrams of these functions can have as well different formats as different values with different meaning (e.g. "0" for switch the lights off and open the shutters). If there were no scene function, you would have to send a single telegram for every actuator to get the same function.

The scene function of the switch actuator enables you to connect the channels of the switch actuator to a scene control. For that, you have to assign the value to the appropriated space (scene A..H). It is possible to program up to 8 scenes per switching output. When you activate the scene function at the switching output, a new sub menu for the scenes appears at the left drop down menu. There are settings to activate single scenes, set values and scene numbers and switch the memory function on/off at this sub menu.

Scenes are activated by receiving their scene numbers at the communication object for the scenes. If the memory function of the scenes is activated, the current value of the channel will be saved at the called scene number.

The communication objects of the scenes have always the length of 1 byte.

The following illustration shows the setting options at the ETS-Software for activating the scene function:

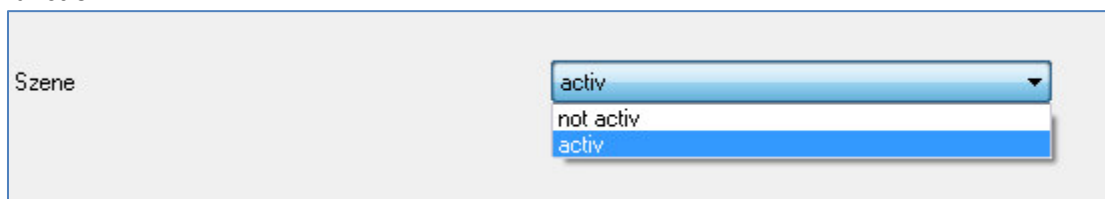

Figure 14: Scene function

The following chart shows the relevant communication object:

Number	Name	Length	Usage
4	Scene	1 Byte	Call of the scene

Table 15: Communication object scene

For calling a certain scene, you have to send the value for the scene to the communication object. The value of the scene number is always one number less than the adjusted scene number. For calling scene 1, you have to send a "0". So the scene numbers have the numbers from 1 to 64, but the values for the scenes only from 0 to 63.

If you want to call scenes by a binary input or another KNX device, you have to set the same number at the calling device as at the receiving device. The calling device, e.g. a binary input, sends automatically the right value for calling the scene.

There are up to 8 storage options for scenes at every channel.
 These 8 storage options can get any of the possible 64 scene numbers.

Channel A, Scene	
Save scene	enabled
Scene A	Off
Scene Number A	1
Scene B	Off
Scene Number B	2
Scene C	Off
Scene Number C	3
Scene D	Off
Scene Number D	4
Scene E	Off
Scene Number E	5
Scene F	Off
Scene Number F	6
Scene G	Off
Scene Number G	7
Scene H	Off
Scene Number H	8

Figure 15: Sub function scene

The chart shows the possible settings for scenes, which are identical for all channels. The settings are available at the sub menu for the scenes:

ETS-text	Dynamic range [default value]	comment
Save scene	<ul style="list-style-type: none"> ▪ disabled ▪ enabled 	Learning of scenarios; enable/disable memory function
Scene A	<ul style="list-style-type: none"> ▪ Off ▪ On 	Activation of the scene A
Scene number A	1-64 [1]	Scene number; Calling value = 1 less than the adjusted scene number
Scene B	<ul style="list-style-type: none"> ▪ Off ▪ On 	Activation of the scene B
Scene number B	1-64 [1]	Scene number; Calling value = 1 less than the adjusted scene number
Scene C	<ul style="list-style-type: none"> ▪ Off ▪ On 	Activation of the scene C
Scene number C	1-64 [1]	Scene number; Calling value = 1 less than the adjusted scene number
Scene D	<ul style="list-style-type: none"> ▪ Off ▪ On 	Activation of the scene D
Scene number D	1-64 [1]	Scene number; Calling value = 1 less than the adjusted scene number
Scene E	<ul style="list-style-type: none"> ▪ Off ▪ On 	Activation of the scene E
Scene number E	1-64 [1]	Scene number; Calling value = 1 less than the adjusted scene number
Scene F	<ul style="list-style-type: none"> ▪ Off ▪ On 	Activation of the scene F
Scene number F	1-64 [1]	Scene number; Calling value = 1 less than the adjusted scene number
Scene G	<ul style="list-style-type: none"> ▪ Off ▪ On 	Activation of the scene G
Scene number G	1-64 [1]	Scene number; Calling value = 1 less than the adjusted scene number
Scene H	<ul style="list-style-type: none"> ▪ Off ▪ On 	Activation of the scene H
Scene number H	1-64 [1]	Scene number; Calling value = 1 less than the adjusted scene number

Table 16: Parameter scene

For calling a scene or saving a new value for the scene, you have to send the accordingly code to the relevant communication object for the scene:

Scene	Retrieve		Save	
	Hex.	Dez.	Hex.	Dez.
1	0x00	0	0x80	128
2	0x01	1	0x81	129
3	0x02	2	0x82	130
4	0x03	3	0x83	131
5	0x04	4	0x84	132
6	0x05	5	0x85	133
7	0x06	6	0x86	134
8	0x07	7	0x87	135
9	0x08	8	0x88	136
10	0x09	9	0x89	137
11	0x0A	10	0x8A	138
12	0x0B	11	0x8B	139
13	0x0C	12	0x8C	140
14	0x0D	13	0x8D	141
15	0x0E	14	0x8E	142
16	0x0F	15	0x8F	143
17	0x10	16	0x90	144
18	0x11	17	0x91	145
19	0x12	18	0x92	146
20	0x13	19	0x93	147
21	0x14	20	0x94	148
22	0x15	21	0x95	149
23	0x16	22	0x96	150
24	0x17	23	0x97	151
25	0x18	24	0x98	152
26	0x19	25	0x99	153
27	0x1A	26	0x9A	154
28	0x1B	27	0x9B	155
29	0x1C	28	0x9C	156
30	0x1D	29	0x9D	157
31	0x1E	30	0x9E	158
32	0x1F	31	0x9F	159

Table 17: Calling and saving scenes

4.4.4.1 Scene programming example

When the scene function is activated for one channel, a new sub menu for the scene of this channel appears. Up to 8 scenes can be adjusted at this sub menu. Every scene gets one scene number, which enables the calling of the scene. You can adjust one specific state for every scene. So you can switch the channel off, with the setting “Off” or switch the channel on with the setting “On”. When the scene is called, the adjusted parameterization of the channel is kept (e.g. on delay, off delay, ...). To note at the scene programming is that if you want to call 2 or more channels with the same scene number, you have to set the both communication objects for the scenes to the same group address. By sending the calling value, both scenes are called. Your programming can become much clearer if you divide your group addresses by scene numbers. If now one channel shall react to 8 scenes, you will have to connect the communication object for the scenes to 8 group addresses.

The following illustrations shall make the division clearly:

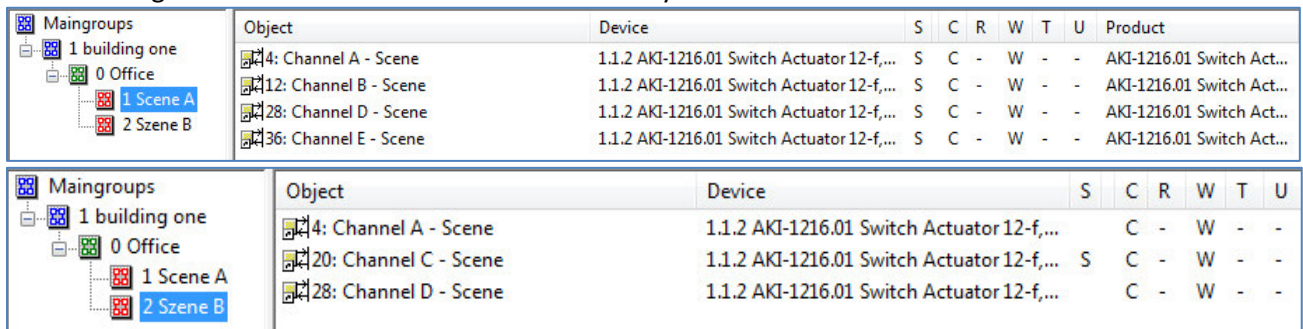

Object	Device	S	C	R	W	T	U	Product
4: Channel A - Scene	1.1.2 AKI-1216.01 Switch Actuator 12-f,...	S	C	-	W	-	-	AKI-1216.01 Switch Act...
12: Channel B - Scene	1.1.2 AKI-1216.01 Switch Actuator 12-f,...	S	C	-	W	-	-	AKI-1216.01 Switch Act...
28: Channel D - Scene	1.1.2 AKI-1216.01 Switch Actuator 12-f,...	S	C	-	W	-	-	AKI-1216.01 Switch Act...
36: Channel E - Scene	1.1.2 AKI-1216.01 Switch Actuator 12-f,...	S	C	-	W	-	-	AKI-1216.01 Switch Act...

Object	Device	S	C	R	W	T	U
4: Channel A - Scene	1.1.2 AKI-1216.01 Switch Actuator 12-f,...		C	-	W	-	-
20: Channel C - Scene	1.1.2 AKI-1216.01 Switch Actuator 12-f,...	S	C	-	W	-	-
28: Channel D - Scene	1.1.2 AKI-1216.01 Switch Actuator 12-f,...		C	-	W	-	-

Figure 16: Programming of scenes

The channels A and D shall react to the call of scene A and scene B. So they are connected to both group addresses.

Furthermore you can save scenes at the according scene numbers. For that you have to activate the memory function at a channel of the switch actuator. Now you can call scenes by a binary input with a short keystroke and save scenes by a long keystroke. The adjusted value for the scene is overwritten by the current state of the actuator, when you save the scenes. At the next call of the scene, the scene will be called with the new value.

4.5 Staircase

The following parameters, which are described at the headings 4.5.x, are only available at channels selected as staircase.

4.5.1 Overview

By choosing a channel as staircase, a sub menu, called Channel A Staircase, appears for this channel at the left drop down menu.

The sub menu is shown at the following illustration:

Mode	normally open
Time for staircase [s]	120
Prewarning	not activ
Manual switching off	not activ
Extend staircase time	not activ
Central function	not activ
Behaviour when locked	no change
Behaviour when unlocked	no change
Behaviour at bus power up	no change
Behaviour at bus power down	no change

Figure 17: Staircase

The chart shows all possible settings for staircase outputs:

ETS-text	Dynamic range [default value]	comment
Mode	<ul style="list-style-type: none"> ▪ normally opened ▪ normally closed 	Operation mode of the channel
Time for staircase [s]	0...65535 sec [120 sec]	Duration of the switching process
Prewarning	<ul style="list-style-type: none"> ▪ not active ▪ active 	Activates the prewarning function
Warning time [s]	0...65535 sec [120 sec]	Duration of the warning; Only available when warning is activated
Prewarning time [s]	0...65535 sec [120 sec]	Adjustment, how long the light shall be switched on after the warning; Whole duration of the warning process is the sum of the 3 times: Staircase time, warning and prewarning Only available when warning is activated
Manual switching off	<ul style="list-style-type: none"> ▪ not active ▪ active 	Activation of the manual turn off of the staircase
Extend staircase time	<ul style="list-style-type: none"> ▪ not active ▪ active 	Activation of the extension of the staircase
Central function	<ul style="list-style-type: none"> ▪ not active ▪ active 	Activates the central function for this channel
Behavior when locked	<ul style="list-style-type: none"> ▪ Off ▪ On ▪ no change 	Action for activating the blocking process
Behavior when unlocked	<ul style="list-style-type: none"> ▪ Off ▪ On ▪ no change 	Action for deactivating the blocking process
Behavior at bus power down	<ul style="list-style-type: none"> ▪ Off ▪ On ▪ no change 	Action for a bus power breakdown
Behavior at bus power up	<ul style="list-style-type: none"> ▪ Off ▪ On ▪ no change 	Action for a bus power return

Table 18: Parameter staircase

4.5.2 Staircase time

The following illustration shows the setting options at the ETS-Software:

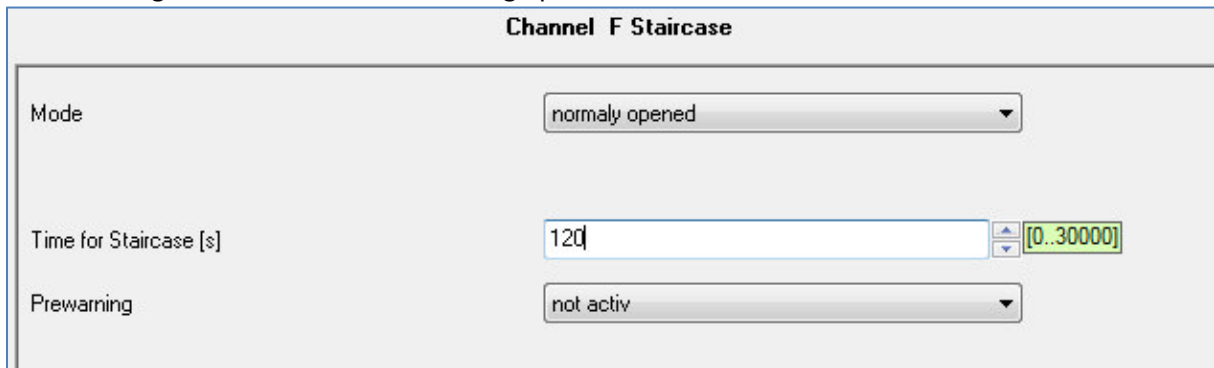

Figure 18: Staircase time

The staircase function is activated by choosing a channel as staircase. This function enables an automatic turn off of the channel after an adjusted time, called “time for staircase”. The time for staircase can be parameterized freely. By sending an “on-signal” at the communication object, the channel is switched on and the time runs out. After the time is ran out, the channel is switched off automatically. There are a lot of further functions to adjust the staircase function. These functions are described at the following segments.

The following chart shows the relevant communication object:

Number	Name	Length	Usage
1	Staircase	1 Bit	Calling of the staircase function

Table 19: Communication object staircase

4.5.3 Prewarning und Warning

The following illustration shows the setting options at the ETS-Software:

Prewarning	activ
Warning Time [s]	1 [0..30000]
Prewarning Time in [s]	10

Figure 19: Warning timer & prewarning time

The warning function can be activated by adjusting the parameter “Prewarning” as active. Now, you can adjust warning time and prewarning time.

The warning function is for warning that the staircase time ran almost out and the lights are switched off soon. This warning happens trough a short turn off the lights. The duration of the turn off is indicated by the warning time. A value of 1-3s is advisable for this parameter. When the warning time runs out, the lights will be switched on again for the adjusted prewarning time. Now you have the opportunities to extend the staircase time, when this parameter was activated, or leave the staircase. A dynamic programming is advisable for this time. So you can adapt this time to spatial conditions (next switch, length of the staircase, etc.).

The whole duration of the switching process is the sum of the 3 times. The following diagram shall make this clear:

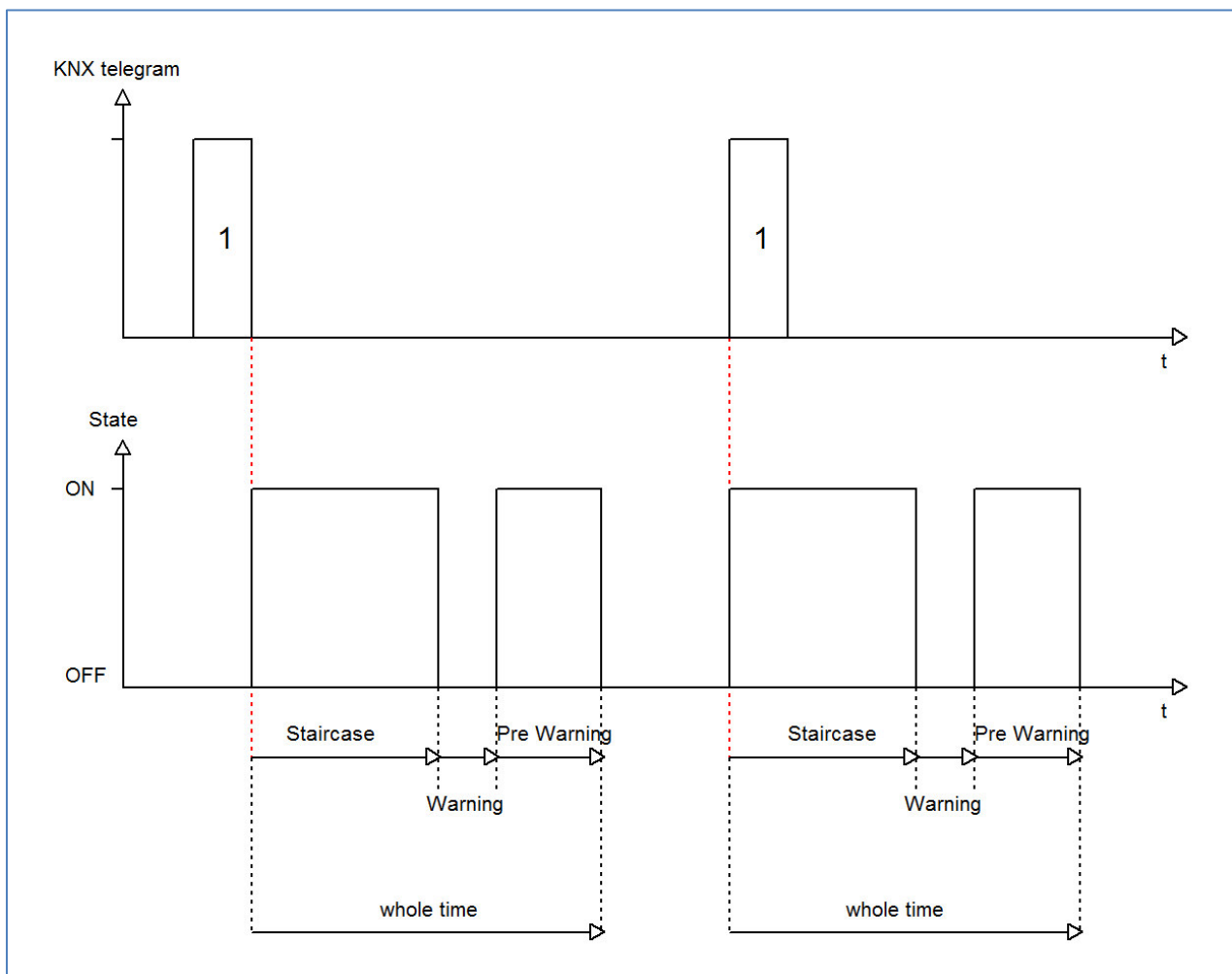

4.5.4 Manual switch off

The following illustration shows the setting options at the ETS-Software:

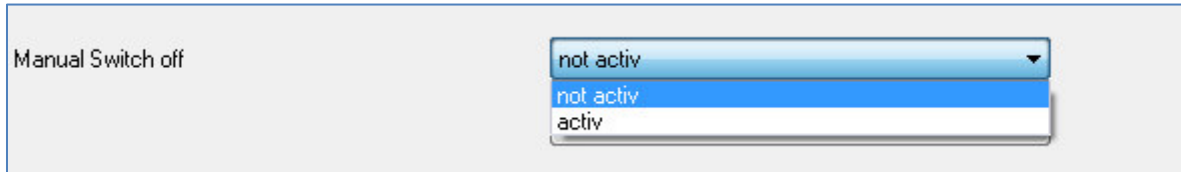

Figure 20: Manual switch off

By activation this function, you can switch the channel off before the staircase time runs out. For switching off the channel, you have to send a logical “0” to the communication object for switching the staircase function (have a look at chart 20, page 27). When this function is not activated, the channel switches only off after the staircase time runs out.

4.5.5 Extend staircase time

The following illustration shows the setting options at the ETS-Software:

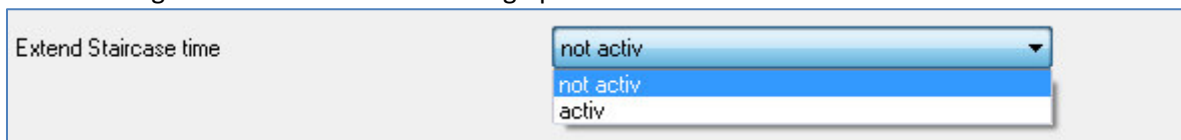
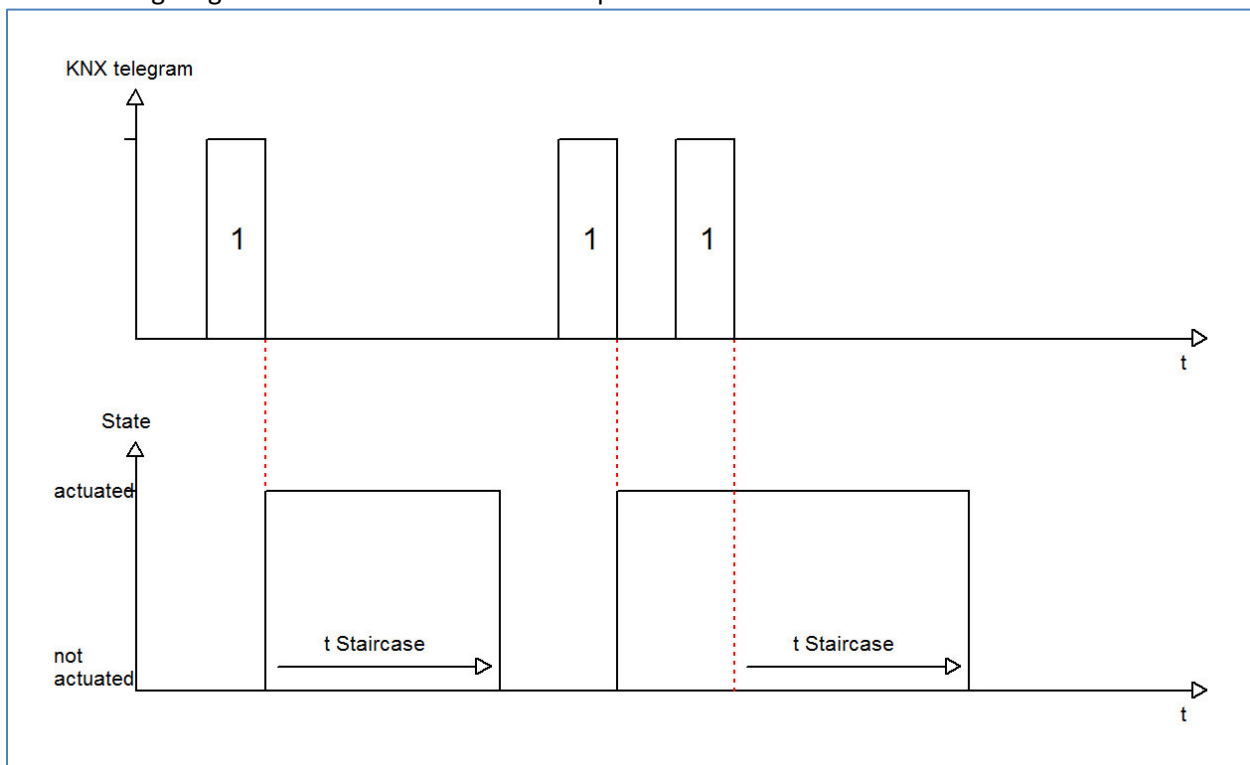

Figure 21: Extend staircase time

By activating this function, the staircase time is retriggerable. That means, when the staircase time runs already out to 2/3, you can restart the time by sending a new on-signal to the communication object of the staircase function (have a look at chart 20, page 27).

The following diagram shows the behavior of this parameter:



5 Index

5.1 Register of illustrations

Figure 5: Exemplary circuit diagram AKK-1610.01	5
Figure 6: Exemplary circuit diagram AKK-0816.02	5
Figure 7: Overview hardware module switch actuator (e.g. AKK-1610.01).....	6
Figure 8: General settings.....	13
Figure 9: Channel selection	14
Figure 10: Operating mode	15
Figure 11: Central function.....	16
Figure 12: Blocking function.....	16
Figure 13: Behavior at bus power up/down.....	18
Figure 14: Switching output	19
Figure 15: On/Off delay.....	21
Figure 16: Logical functions.....	22
Figure 17: Overview Logic function	22
Figure 18: Scene function.....	24
Figure 19: Sub function scene	25
Figure 20: Programming of scenes	28
Figure 21: Staircase	29
Figure 22: Staircase time	31
Figure 23: Warning timer & prewarning time	32
Figure 24: Manual switch off.....	33
Figure 25: Extend staircase time	33

5.2 List of tables

Table 1: Overview functional possibilities.....	7
Table 2: Communication Objects	11
Table 3: Communication objects – default settings.....	12
Table 4: General settings.....	13
Table 5: Channel selection	14
Table 6: Operating mode.....	15
Table 7: Central function.....	16
Table 8: Communication object central function.....	16
Table 9: Behavior at block/unblock.....	16
Table 10: Communication object blocking function.....	17
Table 11: Behavior at bus power up/down.....	18
Table 12: Switching output.....	20
Table 13: Communication objects logic	22
Table 14: Logic function	23
Table 15: Communication object scene	24
Table 16: Parameter scene.....	26
Table 17: Calling and saving scenes.....	27
Table 18: Parameter staircase.....	30
Table 19: Communication object staircase	31

6 Attachment

6.1 Statutory requirements

The above-described devices must not be used with devices, which serve directly or indirectly the purpose of human, health- or lifesaving. Further the devices must not be used if their usage can occur danger for humans, animals or material assets.

Do not let the packaging lying around careless, plastic foil/ -bags etc. can be a dangerous toy for kids.

6.2 Routine disposal

Do not throw the waste equipment in the household rubbish. The device contains electrical devices, which must be disposed as electronic scrap. The casing contains of recyclable synthetic material.

6.3 Assemblage



Risk for life of electrical power!

All activities on the device should only be done by an electrical specialist. The county specific regulations and the applicable EIB-directives have to be observed.

6.4 Datasheet

MDT Switch Actuator compact 2/4/8/16-fold, MDRC

Version		
AKK-0216.01	Switch Actuator 2-fold	2SU MDRC, 230VAC, 16A
AKK-0406.01	Switch Actuator 4-fold	2SU MDRC, 230VAC, 6A
AKK-0816.01	Switch Actuator 8-fold	4SU MDRC, 230VAC, 16A
AKK-0810.01	Switch Actuator 8-fold	4SU MDRC, 230VAC, 10A
AKK-1616.01	Switch Actuator 16-fold	8SU MDRC, 230VAC, 16A
AKK-1610.01	Switch Actuator 16-fold	8SU MDRC, 230VAC, 10A

The MDT Switch Actuator AKK receives KNX/EIB telegrams and switches up to 16 independent electrical loads . Each output uses a monostable relay and can be operated manually via a push button. The outputs are parameterized individually via ETS3f/4. The device provides extensive functions like logical operation, status response, block functions, central function, delay functions and staircase lighting function. Additionally the device provides several time and scene control.

If the mains voltage fails, all outputs were switched off. After mains voltage recovery the relay position will be restored. After bus voltage failure or recovery the relay position is selected in dependence on the parameterization. The MDRC Switch Actuators use a common power supply terminal for four channels. This feature simplifies the wiring and increases clarity of the circuit.

The MDT Switch Actuator AKK is a modular installation device for fixed installations in dry rooms. It fits on DIN 35mm rails in power distribution boards or closed compact boxes.

For project design and commissioning of the MDT Switch Actuator AKK it is recommended to use the ETS3f/ETS4 or later. Please download the application software at www.mdt.de/downloads.html

AKK-0216.01



AKK-0406.01



AKK-0816.01

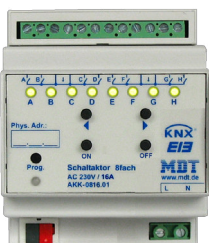

AKK-1616.01

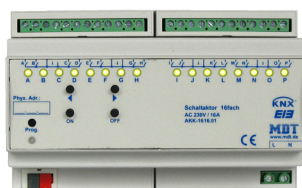

- Production in Germany, certified according to ISO 9001
- Push Button and LED indicator for each channel
- NO and NC contact operation
- Status response after manually operation
- Time functions (switch-on/switch-off delay)
- Staircase light function with adjustable warning time
- Status response (active/passive) for each channel
- Logical linking of binary data
- 8 scenes per channel
- Central switching functions and block functions
- Programmable behavior in case of bus voltage failure or return
- Four contacts share one supply phase
- Integrated bus coupling unit
- 3 years warranty

Technical Data	AKK-02/08/1616.01			AKK-08/1610.01		AKK-0406.01
Number of outputs	2	8	16	8	16	4
Output switching ratings*						
Ohmic load	16A			10A**		6A**
Capacitive load	21uF at 10A			21uF at 10A		7uF at 3A
Voltage	230VAC			230VAC		230VAC
Maximum inrush current	80A/150µs 40A/600µs			80A/150µs 40A/600µs		30A/150µs 15A/600µs
Maximum load*						
Incandescent lamps	2300W			1900W		1000W
Halogen lamps 230V	2000W			1400W		800W
Halogen lamps, electronic transformer	800W			500W		300W
Fluorescent lamps, not compensated	800W			500W		300W
Fluorescent lamps, parallel comp.	180W			120W		60W
Max. number of electronic transformers	3			3		1
Output life expectancy (mechanical)	1.000.000			1.000.000		1.000.000
Permitted wire gauge						
Screw terminal	0,5 - 4,0mm ² solid core 0,5 - 2,5mm ² finely stranded			0,5 - 4,0mm ² solid core 0,5 - 2,5mm ² finely stranded		0,5 - 4,0mm ² solid core 0,5 - 2,5mm ² finely stranded
KNX busconnection terminal	0,8mm Ø, solid core			0,8mm Ø, solid core		0,8mm Ø, solid core
Power supply	KNX bus	230VAC/50Hz		230VAC/50Hz		KNX bus
Power consumption KNX bus***	< 0,3W	< 0,15W	< 0,15W	< 0,15W	< 0,15W	< 0,3W
Power consumption mains 230VAC***	--	0,5-2W	0,5-4W	0,5-2W	0,5-4W	--
Operation temperature range	0 to + 45°C			0 to + 45°C		0 to + 45°C
Enclosure	IP 20			IP 20		IP 20
Dimensions MDRC (Space Units)	2SU	4SU	8SU	4SU	8SU	2SU

* the total current of each supply terminal should not exceed maximum output switching current.

** not suitable to switch AC outlets

*** depends on the switching position of the output relays

Exemplary circuit diagram AKK-0810.01

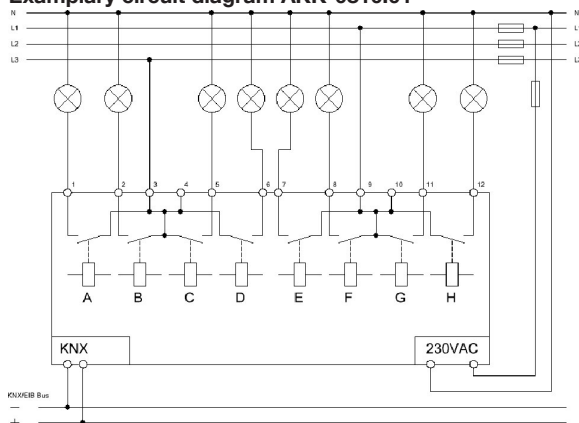

MDT Switch Actuator compact 2/4/8/16-fold, MDRC

Version		
AKK-0216.02	Switch Actuator 2-fold	2SU MDRC, 230VAC, 16A
AKK-0416.02	Switch Actuator 4-fold	2SU MDRC, 230VAC, 16A
AKK-0816.02	Switch Actuator 8-fold	4SU MDRC, 230VAC, 16A
AKK-1616.02	Switch Actuator 16-fold	8SU MDRC, 230VAC, 16A

The MDT Switch Actuator AKK receives KNX/EIB telegrams and switches up to 16 independent electrical loads . Each output uses a bistable relay and can be operated manually via a push button. The outputs are parameterized individually via ETS. The device provides extensive functions like logical operation, status response, block functions, central function, delay functions and staircase lighting function. Additionally the device provides several time and scene control.

If the mains voltage fails, all outputs were switched off. After mains voltage recovery the relay position will be restored. After bus voltage failure or recovery the relay position is selected in dependence on the parameterization. The MDRC Switch Actuators use a common power supply terminal for four channels. This feature simplifies the wiring and increases clarity of the circuit.

The MDT Switch Actuator AKK is a modular installation device for fixed installations in dry rooms. It fits on DIN 35mm rails in power distribution boards or closed compact boxes.

For project design and commissioning of the MDT Switch Actuator AKK it is recommended to use the ETS or later. Please download the application software at www.mdt.de/downloads.html

AKK-0216.02



AKK-0416.02



AKK-0816.02

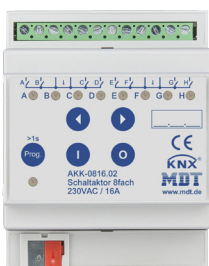

AKK-1616.02



- Production in Germany, certified according to ISO 9001
- Push Button and LED indicator for each channel
- NO and NC contact operation
- Status response after manually operation
- Time functions (switch-on/switch-off delay)
- Staircase light function with adjustable warning time
- Status response (active/passive) for each channel
- Logical linking of binary data
- 8 scenes per channel
- Central switching functions and block functions
- Adjustable behavior in case of bus voltage failure or return
- Four contacts share one supply phase
- Integrated bus coupling unit
- 3 years warranty

Technical Data	AKK-0216.02	AKK-0416.02	AKK-0816.02	AKK-1616.02
Number of outputs	2	4	8	16
Output switching ratings*				
Ohmic load	16A	16A	16A	16A
Capacitive load	21uF at 10A	21uF at 10A	21uF at 10A	21uF at 10A
Voltage	230VAC	230VAC	230VAC	230VAC
Maximum inrush current	80A/150µs 40A/600µs	80A/150µs 40A/600µs	80A/150µs 40A/600µs	80A/150µs 40A/600µs
Maximum load				
Incandescent lamps	2300W	2300W	2300W	2300W
Halogen lamps 230V	2000W	2000W	2000W	2000W
Halogen lamps, electronic transformer	800W	800W	800W	800W
Fluorescent lamps, not compensated	800W	800W	800W	800W
Fluorescent lamps, parallel comp.	180W	180W	180W	180W
Max. number of electronic transformers	3	3	3	3
Output life expectancy (mechanical)	1.000.000	1.000.000	1.000.000	1.000.000
Specification KNX interface	TP-256	TP-256	TP-256	TP-256
Available application software	ETS 3/4/5	ETS 3/4/5	ETS 3/4/5	ETS 3/4/5
Permitted wire gauge				
Screw terminal	0,5 - 4,0mm ² solid core 0,5 - 2,5mm ² finely stranded	0,5 - 4,0mm ² solid core 0,5 - 2,5mm ² finely stranded	0,5 - 4,0mm ² solid core 0,5 - 2,5mm ² finely stranded	0,5 - 4,0mm ² solid core 0,5 - 2,5mm ² finely stranded
KNX busconnection terminal	0,8mm Ø, solid core	0,8mm Ø, solid core	0,8mm Ø, solid core	0,8mm Ø, solid core
Power supply	KNX bus	KNX bus	KNX bus	KNX bus
Power consumption KNX bus	<0,3W	<0,3W	<0,3W	<0,3W
Operation temperature range	0 to +45°C	0 to +45°C	0 to +45°C	0 to +45°C
Enclosure	IP20	IP20	IP20	IP20
Dimensions MDRC (Space Units)	2SU	2SU	4SU	8SU

* the total current of each supply terminal should not exceed maximum output switching current.

Exemplary circuit diagram AKK-0816.02

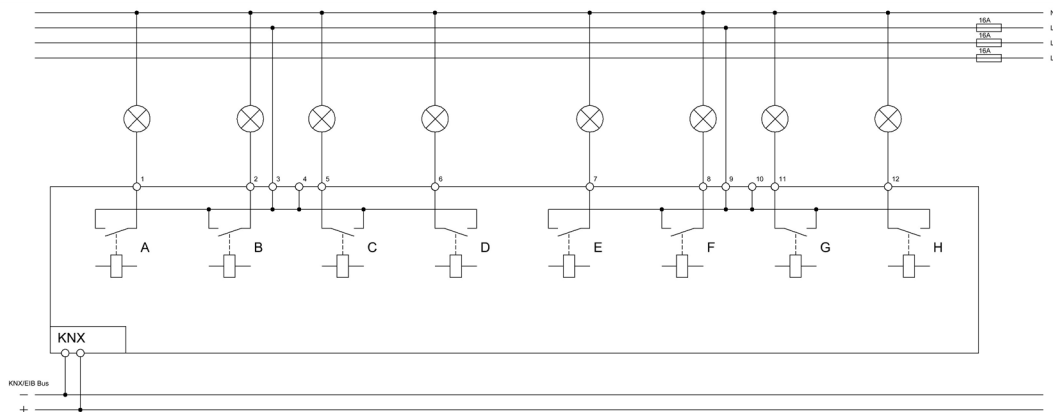

MDT Switch Actuator 1/2-fold, flush mounted

Version		
AKK-01UP.01	Switch Actuator 1-fold	Flush mounted, 230VAC, 16A
AKK-02UP.01	Switch Actuator 2-fold	Flush mounted, 230VAC, 10A

The MDT Switch Actuator AKK receives KNX/EIB telegrams and switches up to 2 independent electrical loads . Each output uses a monostable relay. The outputs are parameterized individually via ETS. The device provides extensive functions like logical operation, status response, block functions, central function, delay functions and staircase lighting function. Additionally the device provides several time and scene control.

If the mains voltage fails, all outputs were switched off. After mains voltage recovery the relay position will be restored. After bus voltage failure or recovery the relay position is selected in dependence on the parameterization.

The MDT Switch Actuator AKK is available as flush mounted installation device for fixed installation in dry rooms.

For project design and commissioning of the MDT Switch Actuator AKK it is recommended to use the ETS. Please download the application software at www.mdt.de/downloads.html

AKK-01UP.01

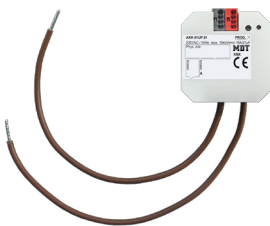

AKK-02UP.01

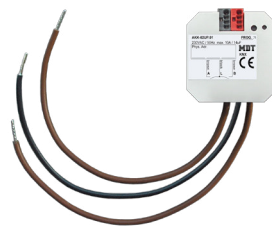

- Production in Germany, certified according to ISO 9001
- NO and NC contact operation
- Time functions (switch-on/switch-off delay)
- Staircase light function with adjustable warning time
- Status response (active/passive) for each channel
- Logical linking of binary data
- 8 scenes per channel
- Central switching functions and block functions
- Adjustable behavior in case of bus voltage failure or return
- Flush mounted in socket
- Integrated bus coupling unit
- 3 years warranty

Technical Data	AKK-01UP.01	AKK-02UP.01	
Number of outputs	1	2	
Output switching ratings			
Ohmic load	16A	10A**	
Capacitive load	21uF at 10A	14uF at 10A	
Voltage	230VAC	230VAC	
Maximum inrush current	80A/150µs 40A/600µs	30A/150µs 15/600µs	
Maximum load			
Incandescent lamps	2300W	1500W	
Halogen lamps 230V	2000W	1200W	
Halogen lamps, electronic transformer	800W	500W	
Fluorescent lamps, not compensated	800W	500W	
Fluorescent lamps, parallel comp.	180W	120W	
Max. number of electronic transformers	3	2	
Output life expectancy (mechanical)	1.000.000	1.000.000	
Fuse protection	16A	10A	
Specification KNX interface	TP-256	TP-256	
Available application software	ETS 3/4/5	ETS 3/4/5	
Permitted wire gauge			
KNX busconnection terminal	0,8mm Ø, solid core	0,8mm Ø, solid core	
Power supply	KNX bus	KNX bus	
Power consumption KNX bus typ.*	<0,3W	<0,3W	
Operation temperature range	0 to + 45°C	0 to + 45°C	
Enclosure	IP 20	IP 20	
Dimensions (W x H x D)	41mm x 41mm x 24mm	41mm x 41mm x 24mm	

* depends on the switching position of the output relays

** Till hardware 3.2 switching power 6A, from hardware 3.3 switching power 10A, max. total current of both channels 16A

Exemplary circuit diagram AKK-01UP.01

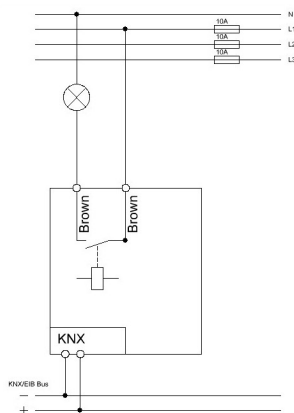

Exemplary circuit diagram AKK-02UP.01

